

# DEA71, DEB71

## Earth leakage monitoring relay



### Benefits

- **Coordination in a system.** DEB71 provides local protection interrupting the power supply only at the point where the fault occurs, through specific settings ( $I\Delta n$ ,  $\Delta t$ ) for each level into which the system is divided.
- **Anti tampering.** Fixed trip levels (DEA71) and sealable front lid (DEB71) provide protection against tampering.
- **Safety against nuisance tripping.** EN 60947-2 Annex M conformity.
- **Output and status LED indication.** Showing at a glance the level of leakage current in real time.
- **Input for remote R / T button.** Input for remote periodical test and for reset of tripped relay after solved fault.

### Description

DEA71 and DEB71 are modular residual current relays which, in conjunction with the MCB and the toroidal leakage current sensor, provide protection against possible risks arising from insulation or grounding faults.

The setpoints can be fixed (DEA71) or adjustable (DEB71).

The device is equipped with two changeover relay outputs.

One output triggers at 60%  $I\Delta n$  providing a warning signal status, the other output triggers at 80%  $I\Delta n$  shutting down the system.

### Applications

DEA71 and DEB71 provide, on all type of residential, commercial and industrial installations, protection to people against the electric shock risk and buildings against the risk of fire.

### Main features

- Type A protection.
- Operating on 1P or 3P systems.
- DIN rail mounting.

**Order code**

Mounting	Trip level	Auxiliary power supply	Component name/part number
DIN-rail	30 mA	24 to 240 V AC	DEA71DM24A003
	300 mA		DEA71DM24A030
	30 mA to 5 A		DEB71DM24A5
	300 mA to 30 A		DEB71DM24A30

**Structure**

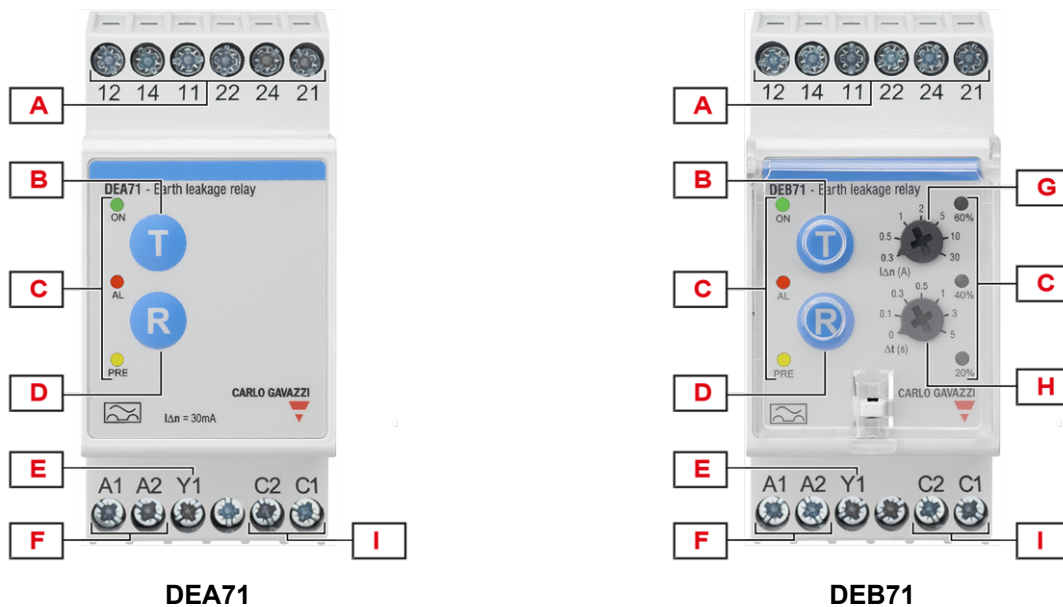

Element	Component	Function
A	Output terminals	2 x SPDT relay outputs
B	Test pushbutton	When pressed it will test the system integrity
C	Information LEDs	Green for device ON Red for signal alarm status Yellow for signal warning status
D	Reset pushbutton	Restores operation after an alarm has been triggered
E	Remote R / T input	Input for remote R / T pushbutton (in conjunction with A2)
F	Power supply terminals	Auxiliary power supply
G	Current leakage dial [ $I_{\Delta n}$ (A)]	Setting the current alarm threshold
H	Delay time dial [ $\Delta t$ (s)]	Setting the alarm ON delay time
I	Input terminals	Input for external core balance transformer (CTG)

## Features

### Power supply

<b>Voltage range</b>	24 to 240 VAC $\pm$ 10%
<b>Overvoltage category</b>	III
<b>Frequency range</b>	50 to 60 Hz $\pm$ 10% sinusoidal waveform
<b>Consumption</b>	< 2.5 VA

### Inputs

Current measuring input	
<b>Terminals</b>	C1, C2
<b>Typology</b>	Residual current measuring from core balance transformer (CTG)
<b>Type</b>	A
<b>CBT type</b>	Only Carlo Gavazzi CTG family types can be used. Select model according to mains cable diameter.
<b>Measuring ranges (I<math>\Delta</math>n)</b>	See the table below
<b>Warning threshold</b>	60% I $\Delta$ n
<b>Alarm threshold</b>	80% I $\Delta$ n
<b>Current overloads (continuous)</b>	See the table below
<b>Resolution (% of the selected I<math>\Delta</math>n)</b>	2%
<b>Accuracy (% of the selected I<math>\Delta</math>n)</b>	10%
<b>Repeatability (% of the selected I<math>\Delta</math>n)</b>	2%
<b>Alarm delay setting <math>\Delta</math>t</b>	0, 0.1 s, 0.3 s, 0.5 s, 1 s, 3 s, 5 s On DEB71DM24A5 when 30 mA I $\Delta$ n is selected, the time is forced to 0 in order to comply with EN 60947-2

Code	Measuring ranges (I $\Delta$ n)	Current overloads (continuous)
DEA71DM24A003	30 mA	5x I $\Delta$ n
DEA71DM24A030	300 mA	5x I $\Delta$ n
DEB71DM24A5	30 mA	150 mA
	100 mA	500 mA
	300 mA	1500 mA
	500 mA	2.5 A
	1 A	5 A
	2 A	10 A
	5 A	10 A

Code	Measuring ranges (I $\Delta$ n)	Current overloads (continuous)
DEB71DM24A30	300 mA	1500 mA
	500 mA	2.5 A
	1 A	5 A
	2 A	10 A
	5 A	25 A
	10 A	30 A
	30 A	40 A

Remote test / reset input	
Terminal	Y1
Typology	Input for push button on connectors Y1, A2
Logic	<b>Remote test:</b> press the external push button for more than 2 s <b>Remote reset:</b> press the external push button for less than 2 s
Logic levels	Open state: > 100 kOhm Closed state: < 100 Ohm
Refresh time	≤ 500 ms

## Outputs

Terminals	11, 12, 14, 21, 22, 24
Number of outputs	2
Type	SPDT electromechanical relay with changeover contacts
Contact rating	<b>AC1:</b> 5 A @ 250 VAC <b>DC12:</b> 5 A @ 24 VDC <b>AC15:</b> 2.5 A @ 250 VAC <b>DC13:</b> 2.5 A @ 24 VDC
Electrical lifetime	≥ 50 x 10 <sup>3</sup> operations (at 5 A, 250 V, cos $\varphi$ = 1)
Mechanical lifetime	> 30 x 10 <sup>6</sup> operations
Reaction time	215 ms (from CT variation detection to relay switching)
Logic	<b>Output 1:</b> de-energised when alarm signal is triggered <b>Output 2:</b> de-energised when warning signal is triggered
Assignment	<b>Output 1:</b> associated to alarm signal <b>Output 2:</b> associated to warning signal

## Insulation

Terminals	Basic insulation
Power supply: A1, A2 and Y1 to outputs: 11, 12, 14, 21, 22, 24	2.5 kVrms, 4 kV impulse 1.2/50 $\mu$ s
Power supply: A1, A2 and Y1 to input: C1, C2	
Output: 11, 12, 14 to output: 21, 22, 24	
Output: 21, 22, 24 to input: C1, C2	

## General

<b>Material</b>	Polyamide (Nylon) (PA66/6) or Phenylene ether + Polystyrene (PPE-PS)
	Flammability rating: V0 according to UL 94
<b>Colour</b>	RAL7035 (light grey)
<b>Front cover material (DEB71)</b>	Transparent polycarbonate
<b>Sealing / locking</b>	Sealing slot
<b>Dimensions (W x H x D)</b>	DEA71: 35.5 x 81 x 67.2 mm (1.40 x 3.19 x 2.65 in) DEB71: 35.5 x 81 x 70.5 mm (1.40 x 3.19 x 2.77 in)
<b>Weight</b>	Approx. 150 g (5.29 oz)
<b>Terminals</b>	Cable size from 0.06 to 3.3 mm <sup>2</sup> (AWG30 to AWG12), stranded or solid
<b>Tightening torque</b>	0.4 to 0.8 Nm (3.540 to 7.080 lbin)
<b>Terminal type</b>	Screw terminals

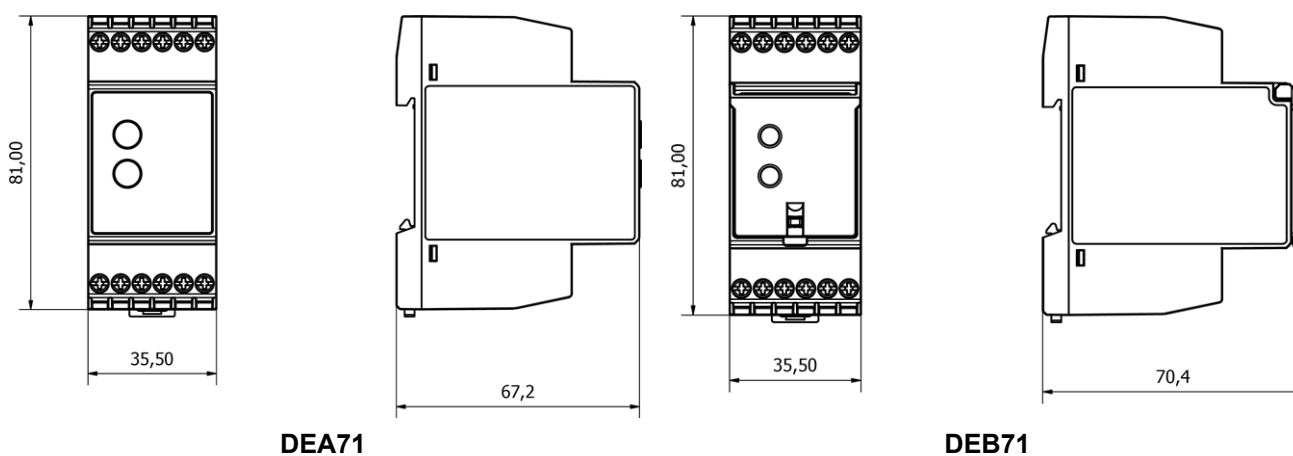

DEA71

DEB71

### Environmental

Operating temperature	-25 to 60 °C (-13 to 140 °F)
Storage temperature	-40 to 80 °C (-40 to 176 °F)
Relative humidity	5 - 95% non condensing
Protection degree	IP20
Pollution degree	2
Operating max altitude	2000 m amsl (6560 ft)
Salinity	Non saline environment
UV resistance	No





### Vibration/Shock resistance

Test condition	Test	Level
Tests with unpacked device	Vibration response (IEC60255-21-1)	Class 1
	Vibration endurance (IEC 60255-21-1)	Class 1
	Shock (IEC 60255-21-2)	Class 1
	Bump (IEC 60255-21-2)	Class 1
Tests with packed device	Vibration random (IEC60068-2-64)	Class 1
	Shock (IEC 60255-21-2)	Class 1
	Bump (IEC 60255-21-2)	Class 1

Class 1: monitoring devices for normal use in power plants, substations and industrial plants and for normal transportation conditions.

The packaging type is designed and implemented in such manner that the severity class parameters will not be exceeded during transportation.

## Compatibility and conformity

Marking	  
Directives	2014/35/EU (LVD - Low voltage) 2014/30/EU (EMC - Electromagnetic compatibility) 2011/65/EU, 2015/863/EU (RoHS)
Standards	EN 60947-2:2017/A1:2020 (annex M) EN 60947-2:2006/A2:2013 (annex M) EN 63000: 2018
Approvals	 (UL508, UL file n. E249822)

## Operating description

### Device configuration

The mains cables are passed through an external CBCT (Core Balance Current Transformer), with the exception of the PE which has to be routed outside.

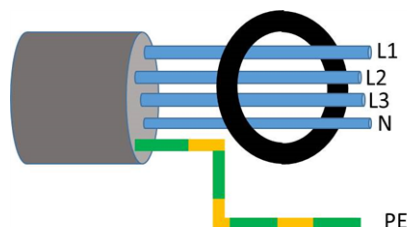

### Only for DEB:

Before starting the operation it is necessary to set the required leakage tripping current  $I\Delta n$ , from 30 mA to 5 A (DEB71DM24A5) or from 300 mA to 30 A (DEB71DM24A30).

Current leakage dial [ $I\Delta n$ (A)]							
	Notch 1	Notch 2	Notch 3	Notch 4	Notch 5	Notch 6	Notch 7
DEB71DM24A5	30 mA	100 mA	300 mA	500 mA	1 A	2 A	5 A
DEB71DM24A30	300 mA	500 mA	1 A	2 A	5 A	10 A	30 A

A delay up to 5 s can also be set.

Delay setting dial [ $\Delta t$ (s)]						
Notch 1	Notch 2	Notch 3	Notch 4	Notch 5	Notch 6	Notch 7
0	100 ms	300 ms	500 ms	1 s	3 s	5 s

Once the setting is completed, the front lid can be closed and sealed to prevent tampering.

Information LEDs

Colour	Status		Description	
Green (ON)	Power supply	ON	Power supply ON	
		OFF	Power supply OFF	
Yellow (20%)	Warning signal	ON	Leakage current $\geq 20\% I_{\Delta n}$	
		OFF	Leakage current $< 20\% I_{\Delta n}$	
Yellow (40%)		ON	Leakage current $\geq 40\% I_{\Delta n}$	
		OFF	Leakage current $< 40\% I_{\Delta n}$	
Yellow (60%)		ON	Leakage current $\geq 60\% I_{\Delta n}$	
		OFF	Leakage current $< 60\% I_{\Delta n}$	
Yellow (PRE)		ON	Leakage current $\geq 60\% I_{\Delta n}$ (relay 2 de-energised)	
		OFF	Leakage current $< 60\% I_{\Delta n}$ (relay 2 energised)	
Red (AL)		Alarm	ON	Leakage current $\geq 80\% I_{\Delta n}$ (relay 1 de-energised)
			Flashing 1 Hz	Leakage current $\geq 80\% I_{\Delta n}$ with a delay on alarm elapsing (relay 1 energised)
	OFF		Leakage current $< 80\% I_{\Delta n}$ (relay 1 energised)	

Operating diagram

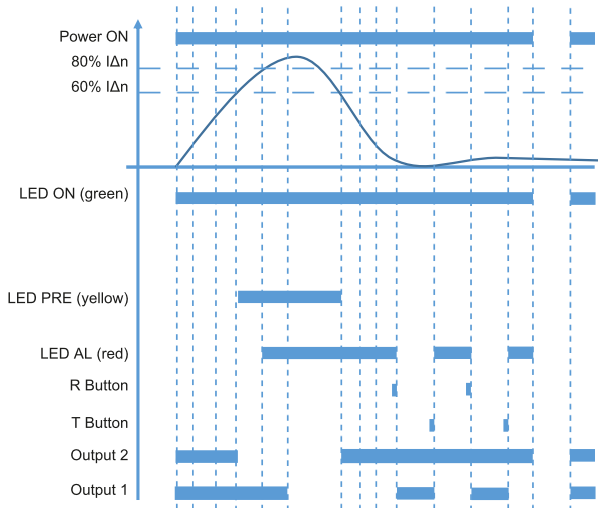

DEA71

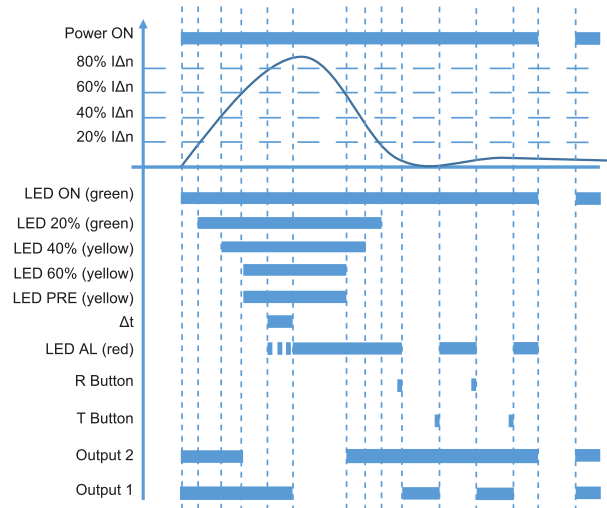

DEB71





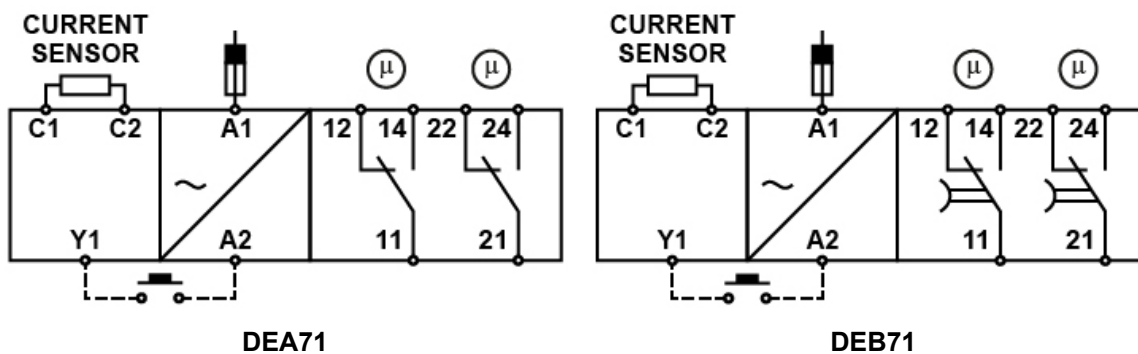

## Connection diagrams



## References

### Further reading

Information	Where to find it	QR code
Installation manual	<a href="https://carlogavazzi-pss.com/manuals/DEA71_DEB71_IM.html">https://carlogavazzi-pss.com/manuals/DEA71_DEB71_IM.html</a>	
PSS selection tool	<a href="https://carlogavazzi-pss.com/">https://carlogavazzi-pss.com/</a>	

**CARLO GAVAZZI compatible components**

Purpose	Component name/code	Datasheet
Core balance transformer, hole Ø 35 mm	<b>CTG035</b>	<a href="https://www.gavazziautomation.com/images/PIM/DATASHEET/ENG/CTG_DS_ENG.pdf">https://www.gavazziautomation.com/images/PIM/DATASHEET/ENG/CTG_DS_ENG.pdf</a> 
Core balance transformer, hole Ø 50 mm	<b>CTG050</b>	
Core balance transformer, hole Ø 70 mm	<b>CTG070</b>	
Core balance transformer, hole Ø 120 mm	<b>CTG120</b>	
Core balance transformer, hole Ø 160 mm	<b>CTG160</b>	
Core balance transformer, hole Ø 210 mm	<b>CTG210</b>	



COPYRIGHT ©2024

Content subject to change. Download the PDF: [www.gavazziautomation.com](http://www.gavazziautomation.com)